

STARLINK | GEN 3 ROUTER SPECIFICATIONS (STANDARD KITS)

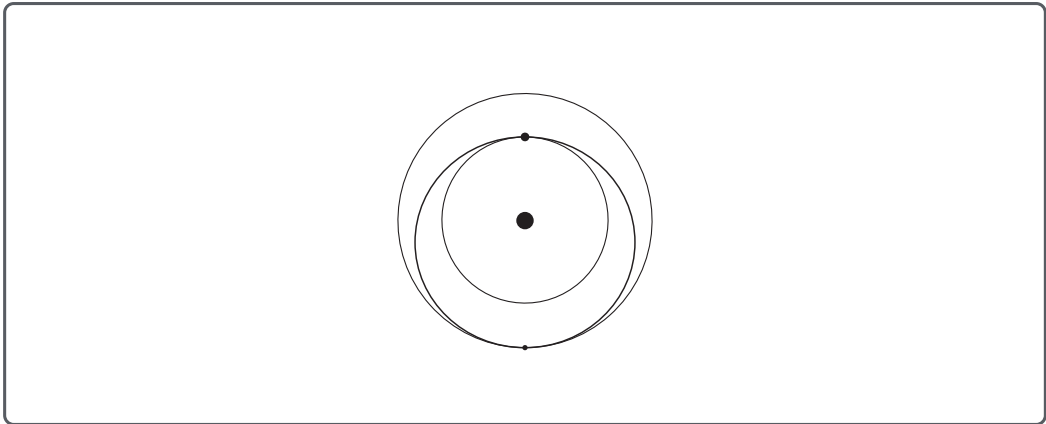

GEN 3 WIFI ROUTER

What's in the box

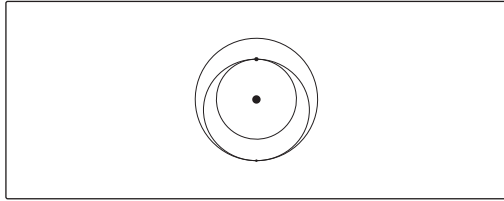

Gen 3 Router



Starlink Plug



RJ45 Cover



Starlink Gen 3 Router Cable

1.5 m
(4.92 ft)

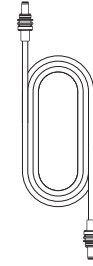

Power Cable

1.5 m
(4.92 ft)

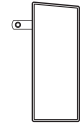

Power Supply

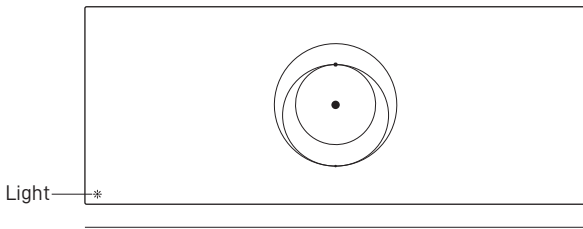

Light*

298.6 mm
(11.76 in)

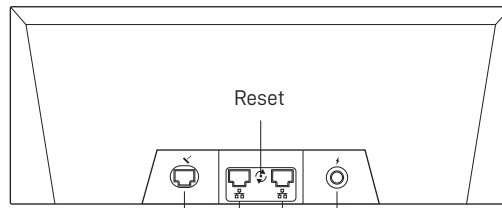

Starlink RJ45 Ports Power

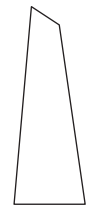

120.4 mm
(4.74 in)

43.4 mm
(1.70 in)

Product Dimensions	2.4" x 11.8" x 4.7" / 55 x 300 x 120 mm
Package Dimensions	14.25" x 6" x 4" / 361 x 154 x 101 mm
Package Weight	6 lbs / 2.7 kg
Wi-Fi Technology	802.11 a/b/g/n/ac/ax
Generation	WiFi 6
Radio	Tri Band 4 x 4 MU-MIMO
Ethernet Ports	Two (2) Latching Ethernet LAN ports with removable cover.
Operating Temperature	-22°F to 122°F / -30°C to 50°C
Weight	2.2 lbs / 1 kg
Security	WPA2
Environmental Rating	IP56 Rated (Water Resistant), configured for indoor use.
Power Indicator	LED face plate, left corner router
Mesh Compatibility	Compatible with Starlink Gen 2 and Gen 3 Mesh nodes. *Not compatible with 3rd party mesh systems.
Devices	Connect up to 235 devices

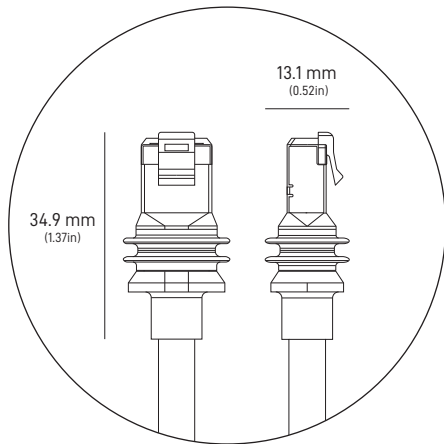
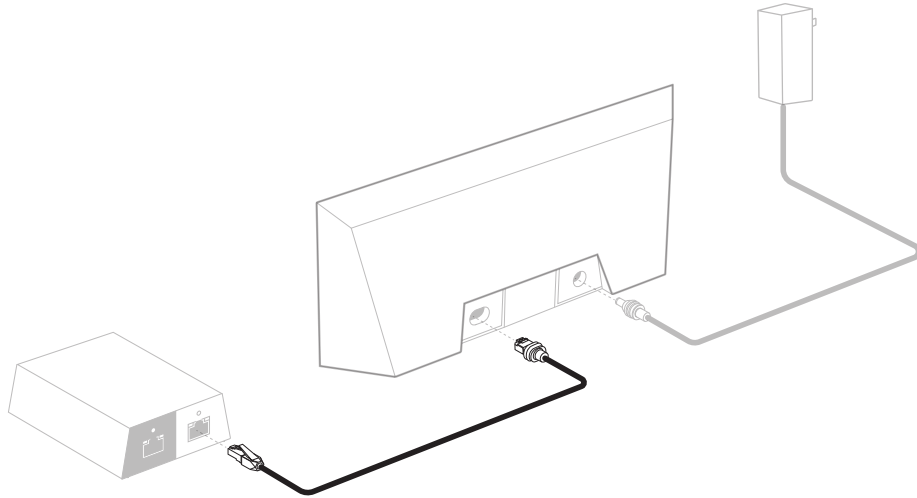

Pin 1	Wire Color	Pin 2
Shield	Drain - Bare Wire	Shield
8	Brown	8
7	White / Brown	7
6	Green	6
5	White / Blue	5
4	Blue	4
3	White / Green	3
2	Orange	2
1	White / Orange	1

